

# OPERATOR'S MANUAL



## EVOTORQUE®2



# CONTENTS

|  |           |
|--|-----------|
| <b>Part Numbers Covered by This Manual</b>           | <b>2</b>  |
| Description Options                                  | 2         |
| Serial Number  | 2         |
| <b>Safety – General Power Tool Safety Warnings</b>   | <b>3</b>  |
| Work Area Safety                                     | 3         |
| Electrical Safety                                    | 3         |
| Personal Safety                                      | 3         |
| Power Tool Use and Care                              | 4         |
| Service  | 4         |
| <b>Safety – EvoTorque®2 Specific Safety Warning</b>  | <b>5</b>  |
| Markings on Tool                                     | 5         |
| EvoTorque®2 Tools without Reaction Bar               | 5         |
| <b>Introduction</b>                                  | <b>6</b>  |
| Parts Included                                       | 6         |
| Accessories  | 7         |
| <b>Features and Functions</b>                        | <b>8</b>  |
| <b>Set Up Instructions</b>                           | <b>10</b> |
| Top Handle   | 10        |
| Torque Reaction                                      | 11        |
| Connecting Supply                                    | 15        |
| Turn On  | 16        |
| Set Direction  | 16        |
| Set Up Targets                                       | 17        |
| View / Select Work Group, Work IDs                   | 18        |
| View / Select Users                                  | 18        |
| Tool Settings  | 19        |
| View Results   | 20        |
| Tool Information                                     | 22        |
| <b>Operating Instructions</b>                        | <b>24</b> |
| Tightening   | 24        |
| Saving Results                                       | 26        |
| Releasing  | 26        |
| <b>Maintenance</b>                                   | <b>27</b> |
| Daily Checks   | 27        |
| Calibration  | 27        |
| Portable Appliance Testing                           | 27        |
| Gearbox  | 28        |
| Drive Square   | 28        |
| Product Disposal                                     | 28        |
| <b>Specifications - EvoTorque®2</b>                  | <b>29</b> |
| <b>Specifications - USB Bluetooth® Smart adapter</b> | <b>31</b> |
| <b>Declaration of Conformity</b>                     | <b>33</b> |
| <b>Trouble Shooting</b>                              | <b>34</b> |
| <b>Glossary of Terms</b>                             | <b>35</b> |

# PART NUMBERS COVERED BY THIS MANUAL

This manual covers the set up and use of Norbar EvoTorque<sup>®2</sup> tools.

| Part Number             | Model            | Torque Range     |
|-------------------------|------------------|------------------|
| 180230.B06              | ET2-72-1000-110  | 100 - 1000 N·m * |
| 180220.B06              | ET2-72-1000-230  | 100 - 1000 N·m * |
| 180231.B06              | ET2-72-1350-110  | 135 - 1350 N·m * |
| 180221.B06              | ET2-72-1350-230  | 135 - 1350 N·m * |
| 180232.B08              | ET2-72-2000-110  | 200 - 2000 N·m * |
| 180222.B08              | ET2-72-2000-230  | 200 - 2000 N·m * |
| 180239.B08              | ET2-80-2700-110  | 270 - 2700 N·m * |
| 180229.B08              | ET2-80-2700-230  | 270 - 2700 N·m * |
| 180233.B08              | ET2-92-2700-110  | 270 - 2700 N·m * |
| 180223.B08              | ET2-92-2700-230  | 270 - 2700 N·m * |
| 180237.B08              | ET2-92-3500-110  | 350 - 3500 N·m * |
| 180227.B08              | ET2-92-3500-230  | 350 - 3500 N·m * |
| 180234.B08 / 180238.B08 | ET2-92-4000-110  | 400 - 4000 N·m * |
| 180224.B08 / 180228.B08 | ET2-92-4000-230  | 400 - 4000 N·m * |
| 180235.B12              | ET2-119-6000-110 | 600 - 6000 N·m * |
| 180225.B12              | ET2-119-6000-230 | 600 - 6000 N·m * |
| 180236.B12              | ET2-119-7000-110 | 700 - 7000 N·m * |
| 180226.B12              | ET2-119-7000-230 | 700 - 7000 N·m * |

\* Note: Calibrated Range of each tool is 20% - 100% Torque Capacity

**NOTE:** The main EvoTorque<sup>®2</sup> models are listed above; other tools with minor variances are also covered.

## Description Options

| Part Number Option | Description        | Options                                      |
|--------------------|--------------------|--|
| ****.B**           | B = Bi-directional | None   |
| ****.XX            | Drive square size  | 06 = 3/4" A/F. 08 = 1" A/F. 12 = 1 1/2" A/F. |

| Model Option     | Description                   | Options   |
|------------------|-------------------------------|---|
| ET2-***-****-*** | ET2 = EvoTorque <sup>®2</sup> | None  |
| ET2-XXX-****-*** | Gearbox diameter              | 72 / 80 / 92 / 119                                    |
| ET2-***-XXXX-*** | Maximum torque in N·m         | 1000 / 1350 / 2000 / 2700 / 3500 / 4000 / 6000 / 7000 |
| ET2-***-****-XXX | Mains supply voltage          | 110=110 V a.c. / 230=230 V a.c.                       |



## Serial Number

The serial number is in the following format: **YYYYAXXXXX**

| Serial Number Code | Description          | Options  |
|--------------------|----------------------|--|
| YYYY*****          | Year of manufacture  |  |
| ****A*****         | Month of manufacture | A=January B= February C= March<br>D= April E= May F=June<br>G=July H=August J=September<br>K=October L=November M=December |
| ****XXXXX          | Serial number        |  |

**NOTE:** Due to the manufacturing process, the calibration date may be after the month of manufacture.

# SAFETY – GENERAL POWER TOOL SAFETY WARNINGS

| Symbol  | Meaning   |
|---|---|
|  | The lightning flash is intended to alert the user to the presence of uninsulated “dangerous voltage” within the products enclosure that may be of sufficient magnitude to constitute a risk of electric shock to persons. |
|  | The exclamation mark is intended to alert the user to the presence of important operating and maintenance (servicing) instructions in the manual.   |



**WARNING: READ ALL SAFETY WARNINGS AND ALL INSTRUCTIONS. FAILURE TO FOLLOW THE WARNINGS AND INSTRUCTIONS MAY RESULT IN ELECTRIC SHOCK, FIRE AND/OR SERIOUS INJURY.**

Save all warnings and instructions for future reference.

The term “power tool” in the warnings refers to your mains-operated (corded) power tool or battery operated (cordless) power tool.

## Work Area Safety

- **Keep work area clean and well lit.** *Cluttered or dark areas invite accidents.*
- **Do not operate power tools in explosive atmospheres, such as in the presence of flammable liquids, gases or dust.** *Power tools create sparks which may ignite the dust or fumes.*
- **Keep children and bystanders away while operating a power tool.** *Distractions can cause you to lose control.*

## Electrical Safety

- **Power tool plugs must match the outlet. Never modify the plug in any way. Do not use any adaptor plugs with earthed (grounded) power tools.** *Unmodified plugs and matching outlets will reduce risk of electric shock.*
- **Avoid body contact with earthed or grounded surfaces, such as pipes, radiators, ranges and refrigerators.** *There is an increased risk of electric shock if your body is earthed or grounded.*
- **Do not expose power tools to rain or wet conditions.** *Water entering a power tool will increase the risk of electric shock.*
- **Do not abuse the cord. Never use the cord for carrying, pulling or unplugging the power tool. Keep cord away from heat, oil, sharp edges and moving parts.** *Damaged or entangled cords increase the risk of electric shock.*
- **When operating a power tool outdoors, use an extension cord suitable for outdoor use.** *Use of a cord suitable for outdoor use reduces the risk of electric shock.*
- **If operating a power tool in a damp location is unavoidable, use a residual current device (RCD) protected power supply.** *Use of an RCD reduces the risk of electric shock.*

## Personal Safety

- **Stay alert, watch what you are doing and use common sense when operating a power tool. Do not use a power tool while you are tired or under the influence of drugs, alcohol or medication.** *A moment of inattention while operating power tools may result in serious personal injury.*

- **Use personal protective equipment (PPE). Always wear eye protection.** *Protective equipment such as a dust mask, non-skid safety shoes, hard hat or hearing protection used for appropriate conditions will reduce personal injuries.*
- **Prevent unintentional starting. Ensure the switch is in the off-position before connecting to power source and/or battery pack, picking up or carrying the tool.** *Carrying power tools with your finger on the switch or energising power tools that have the switch on invites accidents.*
- **Remove any adjusting key or wrench before turning the power tool on.** *A wrench or a key left attached to a rotating part of the power tool may result in personal injury.*
- **Do not overreach. Keep proper footing and balance at all times.** *This enables better control of the power tool in unexpected situations.*
- **Dress properly. Do not wear loose clothing or jewellery. Keep your hair and clothing away from moving parts.** *Loose clothes, jewellery or long hair can be caught in moving parts.*
- **If devices are provided for the connection of dust extraction and collection facilities, ensure these are connected and properly used.** *Use of dust collection can reduce dust-related hazards.*
- **Do not let familiarity gained from frequent use of tools allow you to become complacent and ignore tool safety principles.** *A careless action can cause severe injury within a fraction of a second.*

## Power Tool Use and Care

- **Do not force the power tool. Use the correct power tool for your application.** *The correct power tool will do the job better and safer at the rate for which it was designed.*
- **Do not use the power tool if the switch does not turn it on and off.** *Any power tool that cannot be controlled with the switch is dangerous and must be repaired.*
- **Disconnect the plug from the power source and/or remove the battery pack, if detachable, from the power tool before making any adjustments, changing accessories, or storing power tools.** *Such preventive safety measures reduce the risk of starting the power tool accidentally.*
- **Store idle power tools out of the reach of children and do not allow persons unfamiliar with the power tool or these instructions to operate the power tool.** *Power tools are dangerous in the hands of untrained users.*
- **Maintain power tools and accessories. Check for misalignment or binding of moving parts, breakage of parts and any other condition that may affect the power tool's operation. If damaged, have the power tool repaired before use.** *Many accidents are caused by poorly maintained power tools.*
- **Keep cutting tools sharp and clean.** *Properly maintained cutting tools with sharp edges are less likely to bind and are easier to control.*
- **Use the power tool, accessories and tool bits etc. in accordance with these instructions, taking into account the working conditions and the work to be performed.** *Use of the power tool for operations away from those intended could result in a hazardous situation.*
- **Keep handles and grasping surfaces dry, clean and free from oil and grease.** *Slippery handles and grasping surfaces do not allow for safe handling and control of the tool in unexpected situations.*

## Service

- Have your power tool serviced by a qualified repair person using only identical replacement parts. This will ensure that the safety of the power tool is maintained.

# SAFETY – EVOTORQUE®2 SPECIFIC SAFETY WARNING

This tool is intended for use with threaded fasteners. Tool designation: Screwdriver



**WARNING: IF NOT USED PROPERLY THIS PRODUCT CAN BE DANGEROUS! THIS PRODUCT CAN CAUSE SERIOUS INJURY TO THE OPERATOR AND OTHERS, THE WARNINGS AND SAFETY INSTRUCTIONS MUST BE FOLLOWED TO ENSURE REASONABLE SAFETY AND EFFICIENCY IN USING THIS PRODUCT. THE OPERATOR IS RESPONSIBLE FOR FOLLOWING THE WARNING AND SAFETY INSTRUCTIONS IN THIS MANUAL AND ON THE PRODUCT.**

- Understand the operation of both the TORQUE mode and the ANGLE mode, especially when applied to pre-tightened fasteners. Incorrect tool use can easily apply excessive torque.
- Do not block cooling air entry and exit points.
- Do not pull the mains cable to disconnect from AC outlet, grasp the plug.
- Store tool in carry case after use.
- Isolate the tool from all energy sources before changing or adjusting the drive square socket.
- Always use impact or high quality sockets.
- Use only sockets and adaptors which are in good condition.
- Use only sockets and adaptors which are intended for use with power tools.
- Always operate with a reaction bar that is free to move. Do not fix reaction bar to reaction point.
- For very low torque rate joints (e.g. heat exchangers with long rundown threads) the tool will get warm. In extreme cases the tool safety temperature control will stop the tool.
- It is recommended that Portable Appliance Testing (PAT Testing), officially known as “In-Service Inspection & Testing of Electrical Equipment” is completed at regular intervals, see MAINTENANCE section for more information.

## Markings on Tool

| Pictograms on Tool | Meaning  |
|--------------------|--|
|                    | <b>WARNING: LIVE PARTS INSIDE. DO NOT REMOVE COVER. NO USER SERVICEABLE PARTS INSIDE.</b>  |
|                    | Unexpected tool movement due to reaction forces or breakage of drive square or reaction bar may cause injuries.<br>There is a risk of crushing between the reaction bar and work piece.<br>Keep hands away from reaction bar.<br>Keep hands away from tool output. |
|                    | Read and understand Operator’s Manual.   |

## EvoTorque®2 Tools without a Reaction Bar

Upon customer request some EvoTorque®2 tools are supplied without a reaction bar. These tools MUST NOT be used until a suitable reaction bar has been fitted. Norbar define the reaction bar as ‘interchangeable equipment’ under the European directive 2006/42/EC on Machinery Safety. If applicable a new reaction bar will need to comply with this directive.





# INTRODUCTION

The EvoTorque<sup>®</sup>2 is an electronic torque tool designed for applying torque to threaded fasteners. There are models to cover torque capacities of 1000 N·m to 7000 N·m. The unique 'Intelligent Joint Sensing' technology will accurately tighten to the correct torque without the risk of excess overshoot or undershoot that is common in other electric tools. For fasteners specified in angle, there is an angle mode. Positive confirmation of correct joint tightening is shown on the tool.

The EvoTorque<sup>®</sup>2 has the ability to memorize multiple Targets, Work ID's, User ID's and Readings. Up to 5 Work Groups can co-exist on the EvoTorque<sup>®</sup>2 which can be sequential or user selectable.

The EvoTorque<sup>®</sup>2's functionality is greatly enhanced when used with the EvoLog PC/Tablet software included with the tool. Connection is possible via USB or the USB Bluetooth<sup>®</sup> Smart adapter (included).

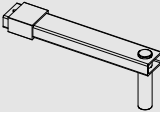
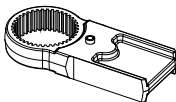

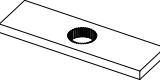

## Parts Included

| Description   | Mode  |   |  |   |
|---|---|---|--|---|
|   | ET2-72  | ET2-80  | ET2-92   | ET2-119   |
| Maximum Torque  | 1000 N·m<br>1350 N·m<br>2000 N·m  | 2700 N·m  | 2700 N·m<br>3500 N·m<br>4000 N·m   | 6000 N·m<br>7000 N·m  |
| Visual Difference   |  |  |  |  |
| Steel Reaction Bars                                       | 19289   | 19289   | 19291  | 19293   |
| Reaction Bar Retaining Circlip                            | 26486   | 26486   | 26486  | 26482   |
| Spare Drive Square  | 18779 (1000 N·m)<br>18779 (1350 N·m)<br>18492 (2000 N·m)                          | 19431   | 18934  | 18959   |
| 4mm Hex Key for Drive Square                              | 24953   | 24953   | 24953  | 24953   |
| Infill for Top Handle (2 off)                             | 19128   | 19128   | 19128  | 19128   |
| 5mm Hex Key for Top Handle                                | 24952   | 24952   | 24952  | 24952   |
| Mains Adaptor (where required)                            | See table below   | See table below   | See table below  | See table below   |
| EvoTorque <sup>®</sup> 2 Operator's Manual                | 34426   | 34426   | 34426  | 34426   |
| USB memory stick with EvoLog software & Operator's Manual | 61139   | 61139   | 61139  | 61139   |
| USB Bluetooth <sup>®</sup> Smart adapter                  | 43513   | 43513   | 43513  | 43513   |
| USB lead (2 m)  | 39777   | 39777   | 39777  | 39777   |

| Mains Adaptor Part Number |                    |       |       |       |         |       |        |            |         |
|---------------------------|--------------------|-------|-------|-------|---------|-------|--------|------------|---------|
| Mains Voltage             | Socket (IEC 60309) | Plug  |       |       |         |       |        |            |         |
|                           |                    | USA   | UK    | Euro  | Italian | Swiss | Danish | Australian | No Plug |
| 110 V                     | Yellow             | 39618 | -     | -     | -       | -     | -      | -          | 39623   |
| 230 V                     | Blue               | -     | 39616 | 39617 | 39619   | 39621 | 39647  | 39620      | 39624   |

**NOTE:** The mains adaptors are NOT IP44 rated.

## Accessories

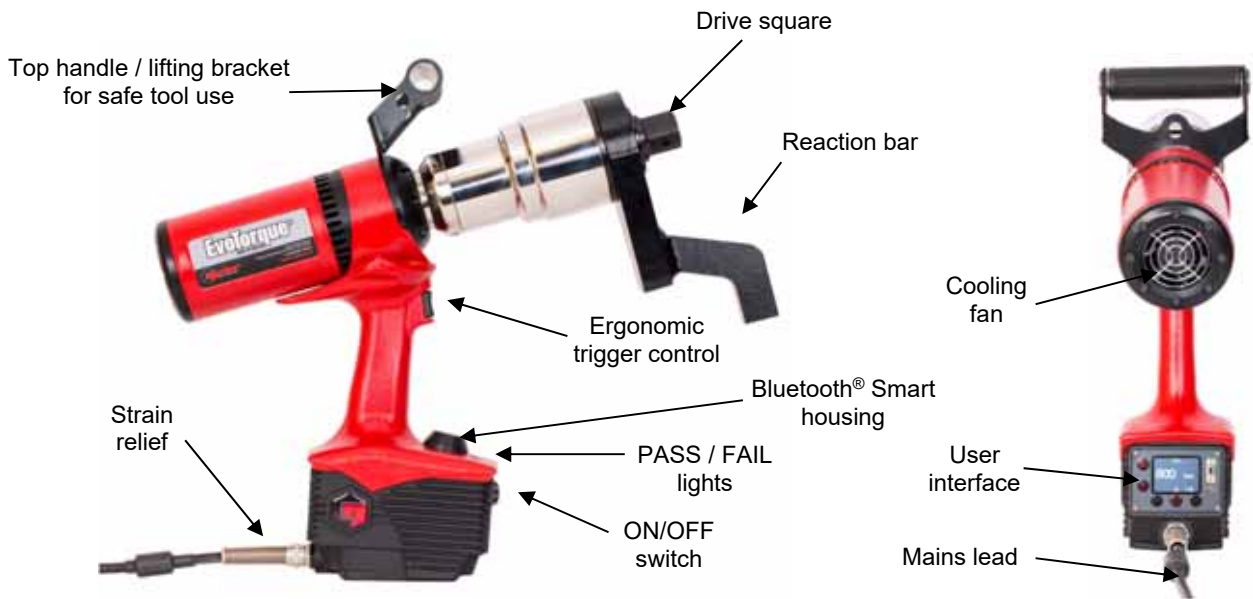
| Description   | Mode                             |                     |                     |                     |
|---|----------------------------------|---------------------|---------------------|---------------------|
|   | ET2-72                           | ET2-80              | ET2-92              | ET2-119             |
| ¾" Drive Square<br>(Fixing Screw)   | 18779<br>(25325.45)              | -                   | -                   | -                   |
| 1" Drive Square<br>(Fixing Screw)   | 18492<br>(25352.45)              | 19431<br>(25352.40) | 18934<br>(25352.60) | -                   |
| 1 ½" Drive Square<br>(Fixing Screw)   | -                                | -                   | 18935<br>(25352.60) | 18959<br>(25352.80) |
| Reaction Bar (NOTE)<br>              | 18298                            | -                   | -                   | -                   |
| Reaction Bar Adaptor<br>(NOTE)<br>   | 18290                            | -                   | -                   | -                   |
| Single-Sided Reaction<br>Plate<br>   | 18292                            | 18292               | 18979               | 16687               |
| Double-Sided Reaction<br>Plate<br> | 18293                            | 18293               | 18980               | 18981               |
| Cranked Reaction Foot<br>          | 18494                            | 18936               | 18936               | 18961               |
| 6" Blade Nose Extension   | (1") 18755.006                   | -                   | -                   | -                   |
| 9" Blade Nose Extension   | (1") 18755.009                   | -                   | -                   | -                   |
| 12" Blade Nose Extension  | (1") 18755.012                   | -                   | -                   | -                   |
| 9" Nose Extension for<br>Truck and Bus Wheels   | (¾") 19087.009<br>(1") 19089.009 | -                   | -                   | -                   |
| 12" Nose Extension for<br>Truck and Bus Wheels  | (¾") 19087.012<br>(1") 19089.012 | -                   | -                   | -                   |
| Carry Case  | 26969                            | 26969               | 26970               | 26970               |

**NOTE:** Requires both "Reaction Bar" and "Reaction Bar Adaptor" to be used together.

Reactions to suit specific applications can be supplied, contact Norbar or a Norbar distributor for details.



# FEATURES AND FUNCTIONS



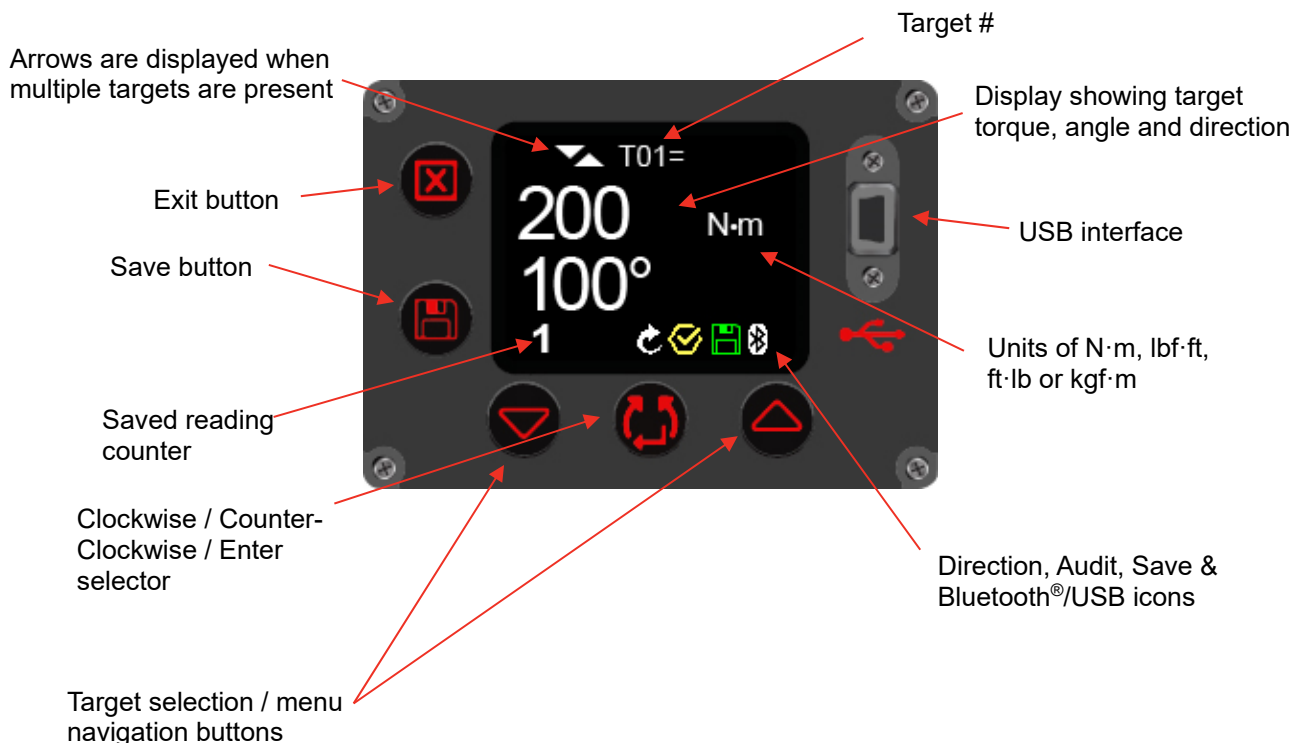
**FIGURE 1 – Tool Features**

- 4 operational modes – Torque, Torque & Angle, Torque & Angle with Final Torque or Torque Audit.

| Mode                             | Description  |
|----------------------------------|--|
| Torque                           | Fast tightening of fastener to torque value.   |
| Torque & Angle                   | Tightening to snug torque followed by angle specification for fastener.                              |
| Torque & Angle with Final Torque | Tightening to snug torque followed by angle with final torque monitoring specification for fastener. |
| Torque Audit                     | For checking pre-tightened fasteners.  |

- Colour Display.
- Display and on board storage of final Torque (& Angle) values.
- 3000 (time and date stamped) reading memory.
- USB & Bluetooth® data transfer.
- Complimentary PC software “EvoLog”.
- Display can be powered from USB for interface to EvoLog. No separate tool mains power required.
- Ability to download up to 12 User ID’s to the tool.
- 20 unique Standalone Targets +20 unique Work Group Targets for each Work Group.
- 12 Standalone Work ID’s +12 Work ID’s in each Work Group.
- Ability to have up to 5 Work Groups with a maximum of 144 steps, distributed over a maximum of 12 Work IDs on the tool.
- Ability to set Final Torque Target for a Snug Torque followed by Angle Target.
- Snug Torque followed by Angle can be set as a fast 2 Stage Target.
- ASCII interface to allow integration into third part control systems (like ProTight).
- Graphing feature for the display of fastener profiles via Evolog.
- Usage counter for monitoring of specific jobs.
- Ability to set direction of operation of the tool Target.
- Ability to set Turn Angle for a Torque only joint.

- Tool can be locked to 2 different functional levels.
- Send 'Log Results' in real time.
- Output results in CSV format (USER mode).
- Factory calibrated to  $\pm 3\%$ .
- Ability to define pass fail result tolerances.
- Using patent pending "Intelligent Joint Sensing" technology to continually measure the joint during tightening. As the fastener is tightened the tool will sense the joint type (hard / soft) and act accordingly. As the fastener is tightened dynamic braking is used to ensure the target torque is correctly reached and eliminate the potential for a large over torque due to tool inertia.
- Models covering 8 torque ranges up to 7000 N·m.
- Very quiet operation.
- Very low vibration levels using a non-impacting mechanism; this leads to comfortable and safe use with less damage to the tool, socket and threaded assembly.
- IP44 environmental rating (protection against 1mm solid objects & splashing water).
- Versions for 110 V a.c. or 230 V a.c.
- Reaction forces are contained by the reaction bar, so forces are not passed back to the operator.
- Several reaction bar styles available, including versions for restricted applications.
- Tool operational from 10% to 100% (calibrated from 20% to 100%) of rated torque capacity.
- Brushless motor for low maintenance.



**FIGURE 2 – User Interface Features**

**NOTE:** The saved reading counter will be shown as 1/x, 2/x etc (where x is the 'Number of Readings' specified in a Target set up on EvoLog) when performing a Work Group. See EvoLog Operator's Manual (part # 34427) for more information.

# SET UP INSTRUCTIONS

**NOTE:** If the equipment is used in a manner not specified by the manufacturer, the protection provided by the equipment may be impaired.



**WARNING:** ALLOW THE TOOL TO EQUALISE TO THE AMBIENT TEMPERATURE / HUMIDITY BEFORE SWITCHING ON. WIPE OFF ANY MOISTURE BEFORE USE.

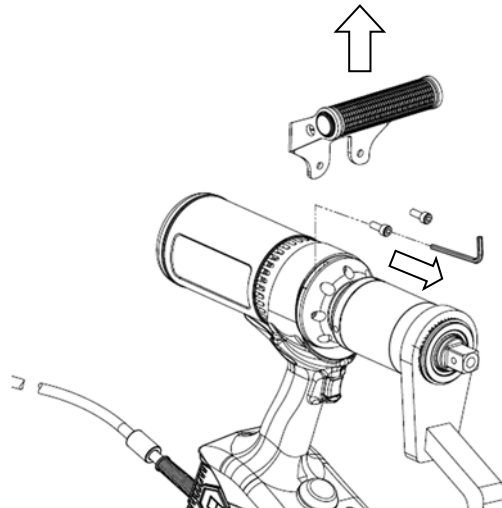
Please complete the set up in the order shown.

## Top Handle

The tool is supplied with a top handle attached to the tool. For hand held use it is recommended to always use the top handle as loss of tool control can cause personal injury. If a hanger (balancer) is required, attach to top handle.

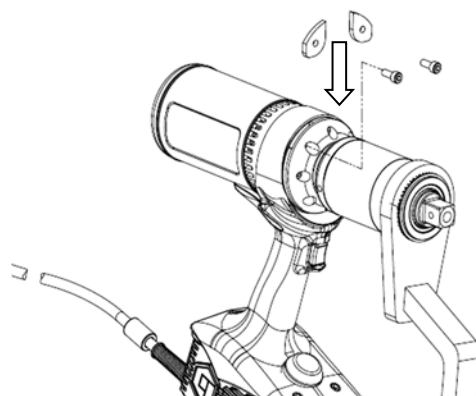
Should the top handle not be required it can be removed as follows:

1. Use 5mm hex key (supplied) to remove fixing bolts, see figure 3, then remove handle



**FIGURE 3 – Removal of Top Handle**

2. Install two infills (supplied) then re-fit bolts; see figure 4.  
The infills must be fitted to maintain the tool's environmental rating.




**FIGURE 4 – Install infills**

# Torque Reaction

The reaction bar ensures all reaction forces are contained, so torque reaction is not passed back to the operator. Several reaction bar styles are available.

Fit reaction bar as detailed below.

| Reaction Bar Type                    | Fitting Instructions   |
|--------------------------------------|--|
| Cranked Reaction Bar (Standard)      | Fit reaction bar / plate over the drive square to engage reaction splines. Secure with circlip supplied. |
| Single Sided Reaction Plate (Option) |  |
| Double Sided Reaction Plate (Option) |  |
| Nose Extension (Option)              | Fit as per instructions supplied with nose extension.  |

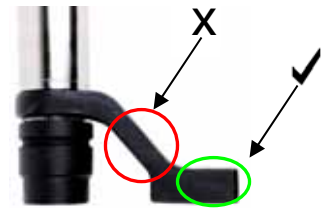


**FIGURE 5 – Nose Extension**

It is essential the reaction bar rests squarely against a solid object or surface adjacent to the fastener to be tightened.

DO NOT react on the surface circled in red on figure 6.

React on the end of the reaction bar, circled in green on figure 6, using the maximum area possible.

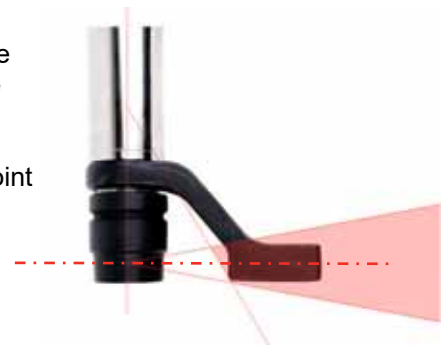


**FIGURE 6 – Cranked Reaction Bar (Steel or Aluminium)**

The ideal reaction arrangement has the centre of the reaction bar and the centre of the nut on a perpendicular line to the centre line of the tool, see figure 7.

The supplied reaction bar has been designed to give an ideal reaction point when used with a standard length socket.

To allow for a small difference in socket length the reaction bar may contact any point within the shaded area of figure 7.



**FIGURE 7 – Standard Length Socket Safe Reaction Window**



**WARNING: IF THE REACTION POINT IS OUTSIDE THE SHADED AREA EXCESSIVE LOADS MAY BE PLACED ON THE TOOL LEADING TO POTENTIAL OPERATOR INJURY AND DAMAGE TO THE TOOL.**

If an extra long socket is used it may move the reaction bar outside the safe reaction window, as seen in figure 8.

The standard reaction bar may need to be extended to ensure it remains within the shaded area.

For alternative reaction bars see ACCESSORIES list.



**FIGURE 8** – Extra Long Socket  
Safe Reaction Window



**WARNING: IF MODIFYING THE STANDARD REACTION BAR ENSURE IT IS CAPABLE OF TAKING THE MAXIMUM LOAD OF THE TOOL. FAILURE OF THE REACTION BAR CAN ENDANGER OPERATOR SAFETY AND DAMAGE THE TOOL.**

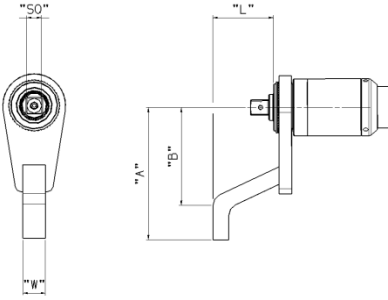
Standard drive square extensions, see figure 9, **MUST NOT** be used as these will cause serious damage to the tool output drive.

A range of nose extensions is available for applications where access is restricted. These are designed to support the final drive correctly.

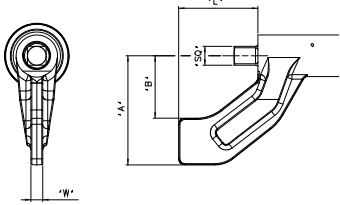


**FIGURE 9** – Drive Square Extension

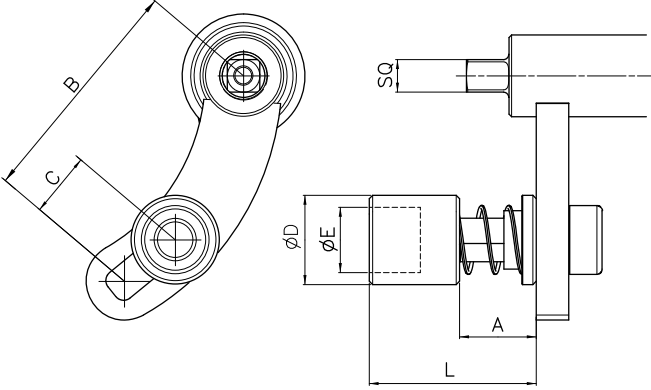
The dimensions of the standard reaction bars are shown in the following table:

| Steel Reaction Bar (Supplied)   | Tool    | 'L' | 'A' | 'B' | 'W' | 'SQ'       |
|---|---------|-----|-----|-----|-----|------------|
|  | ET2-72  | 77  | 167 | 124 | 29  | 3/4" or 1" |
|   | ET2-80  | 77  | 167 | 124 | 29  | 1"         |
|   | ET2-92  | 75  | 175 | 125 | 29  | 1"         |
|   | ET2-119 | 95  | 210 | 161 | 35  | 1 1/2"     |

**FIGURE 10 – Reaction Bar**





| Blade Nose Extension (Optional Accessory)   | Tool                 | 'L'  | 'A' | 'B' | 'W' | 'SQ' |
|---|----------------------|------|-----|-----|-----|------|
|  | ET2-72<br>(1000 N·m) | 80.5 | 110 | 63  | 12  | 3/4" |
|   | ET2-92<br>(2000 N·m) | 51.5 | 110 | 62  | 16  | 1"   |

**FIGURE 11 – Blade Nose Extension**

| Nose Extension for Truck and Bus Wheels (Optional Accessory)                        | L  | A  | B     | C  | ØD | ØE | SQ         |
|---|----|----|-------|----|----|----|------------|
|  | 98 | 47 | 132.5 | 29 | 52 | 38 | 3/4" or 1" |

**FIGURE 12 – Nose Extension for Truck and Bus Wheels**

When the EvoTorque<sup>®</sup>2 is in operation the reaction bar rotates in the opposite direction to the output drive square and must be allowed to rest squarely against a solid object or surface adjacent to the fastener to be tightened. (See figure 13 - 16).

| EvoTorque <sup>®</sup> 2 Type                                       | Torque Reaction   |  |
|---|---|--|
|   | Clockwise   | Counter – Clockwise  |
| Example of EvoTorque <sup>®</sup> 2 Tool                            |  <p>FIGURE 13</p>  |  <p>FIGURE 14</p>  |
| Example of EvoTorque <sup>®</sup> 2 tool with nose extension option |  <p>FIGURE 15</p> |  <p>FIGURE 16</p> |



**WARNING:** ALWAYS KEEP HANDS CLEAR OF THE REACTION BAR WHEN THE TOOL IS IN USE OR SERIOUS INJURY MAY RESULT.



## Connecting Supply



**WARNING:** THE TOOL HAS BEEN DESIGNED FOR ONE VOLTAGE ONLY. CHECK THAT THE POWER SUPPLY CORRESPONDS TO THE VOLTAGE ON THE TOOL RATING PLATE.



**WARNING:** THE TOOL MUST BE EARTHED ENSURE POWER SUPPLY HAS AN EARTH DO NOT OPERATE WITHOUT AN EARTH



**WARNING:** FOR OPERATOR SAFETY ENSURE THE MAINS SUPPLY HAS A RESIDUAL CURRENT DEVICE (RCD). TEST THE RCD REGULARLY.

Connect plug to local mains supply.

**TIP: Supply Circuit Breaker:**

If the mains supply is fitted with a circuit breaker ensure it is TYPE C (as defined in IEC / EN 60898-1) or above to eliminate false trips.

To maintain the environmental rating the tool has been factory fitted with a suitable plug to IEC 60309.

The plug will either be coloured blue (for 230 V a.c. models) or yellow (for 110 V a.c. models).

It is important to connect directly to a local supply socket outlet of the same type.

**TIP: Use of a Different Local Supply Socket:**

The tool is supplied with a plug rated to IEC 60309 for industrial locations.

An adaptor (where supplied) can be used to convert to a non-industrial plug; see INTRODUCTION for plug options.

Should a different plug be required, the mains cable colours are:

**BROWN-LIVE**

**BLUE-NEUTRAL**

**GREEN/YELLOW-EARTH**

The new plug must have a ground (**EARTH**) connection.

Ensure the plug is rated for voltage/current of tool.

If in doubt consult a qualified electrician.

**TIP: Minimum Power Requirement:**

Use tool on either a quality mains (grid) supply or a generator rated at 5KVA minimum. Other power sources, like local networks, may not be adequate to power the tool.

Use 230V tool if possible as they are subject to less cable voltage drop and able to withstand larger drops in voltage.

Use tool close to power outlet, if an extension cable is required observe the following limitations:

For 110V tools use  $\varnothing 1.5\text{mm}^2$  / 14 AWG cable up to 25m or  $\varnothing 2.5\text{mm}^2$  / 10 AWG cable up to 75m.  
For 230V tools use  $\varnothing 1.5\text{mm}^2$  / 14 AWG cable up to 50m or  $\varnothing 2.5\text{mm}^2$  / 10 AWG cable up to 100m.

Ensure extension cable is made up in a maximum of two (2) separate lengths to reduce plug / socket connections.

Ensure extension cable is completely unwound.

The above requirement is for using 1 tool.



## Turn On

Turn on mains supply. Change ON/OFF switch from 0 to I.

The logo is shown for 2 seconds:



FIGURE 17 – Norbar Logo

The capacity is shown for 2 seconds:

**TIP:** Fan operation: During the logo & capacity screens the fan will run to give confirmation that it is working.



FIGURE 18 – Tool Capacity, Operational Voltage, Time & Date

The target screen is shown:

The Target and direction are remembered from the last use.



FIGURE 19 – Torque & Angle Target

## Set Direction


Press  to set direction. This cannot be done when the tool is running.



FIGURE 20 – Set Direction


The tool is now ready to use. Press trigger and the following screen will be shown.

**TIP:** The tool operation is dependant on the Target Set Up i.e. Torque, Torque & Angle or Torque Audit.






FIGURE 21 – Run screen

## Set Up Targets

Press  to exit the Run screen and show the Menu screen.

Select  and press  to view targets.

Press  or  to highlight required Target # (T01 – T20).

Press  to enter Target Set Up / edit.

Press  to increase,  decrease the Torque Target value.

**TIP:** Keep button pressed for rapid rate of target change.

When set press  to accept.

Press  to increase,  to decrease Angle Target value. This is angle applied after torque is applied.

**TIP:** Keep button pressed for rapid rate of angle target change.

If in doubt leave as 0°

When set press  to accept.

**NOTE:** This screen will only be shown if the angle target was set larger than '0°' on the Set Angle screen.

Press  to increase,  decrease the Final Torque Target value.

When set press  to accept.



FIGURE 22 – Select Target Set Up



FIGURE 23 – Select Target #



FIGURE 24 – Set Target Torque





FIGURE 25 – Set Target Angle



FIGURE 26 – Set Final Torque Target

**NOTE:** This screen will only be shown if the angle target was '0°' on the Set Angle screen.



Press  or  to enable '✓' or disable '✗'.

When set press  to accept.



FIGURE 27 – Set Audit Target

**NOTE:** This screen will only be shown if the Audit mode? was '✓' on the previous screen.


Press   to increase/decrease the Tolerance value.

This is the expected / allowable angle the bolt can move on by.



FIGURE 28 – Set Tolerance

## View / Select Work Groups & Work IDs

Press  to View/Select the Work Group or any standalone Work IDs on the tool. These can only be populated on the tool via EvoLog, see EvoLog Operator's Manual part # 34427 for more details.

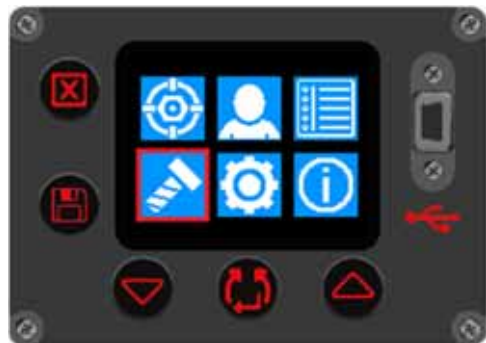



FIGURE 29 – View / Select Work Groups & Work ID's

## View / Select Users

Press  to View/Select any User IDs on the tool. These can only be populated on the tool via EvoLog, see EvoLog Operator's Manual part # 34427 for more details.

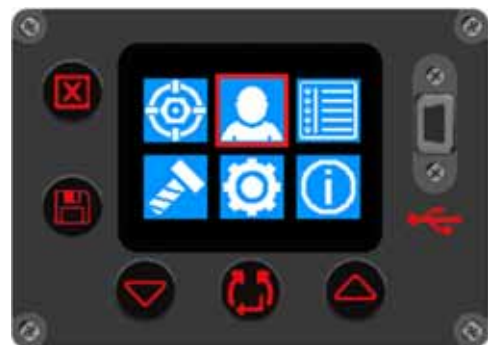


FIGURE 30 – View / Select Users

## Tool Settings

This menu is used to set or view the Unit, Auto Reset, Lock, Bluetooth®, Time & Date, Display, Tolerances, Output Format, 2 Stage Target and Operation Direction.



FIGURE 31 – Tool Settings Menu



FIGURE 33 – Tool Set Up options 1

The Lock screen will appear if 'Lock' has been set.




FIGURE 32 – Unlock Tool




FIGURE 34 – Tool Set Up options 2

Enter PIN code to unlock using the  or  buttons.

Confirm each number by pressing the  button.

| Menu Option    | Details  |
|----------------|--|
| Unit           | Select N·m, lbf·ft, ft·lb or kgf·m.  |
| Auto Reset     | ✓ = Enabled (Hold time 2 -10 seconds) / ✗ = disabled (Manual Reset).   |
| Lock           | Lock Level<br>Off= Disabled.<br>1 = Enabled (No access to Tool settings, Erase results. No Target adjustment)<br>2 = Enabled (No exit from Run screen, no multiple Target selection)<br><br>(default Unlock PIN = 5000).The PIN can be set anywhere in the range 0000 to 9999<br><br><b>TIP: Keep a note of the pin code in a safe place</b> |
| Bluetooth®     | ✓ = Enabled (Bluetooth® Smart) / ✗ = disabled.   |
| Time & Date    | hh:mm:ss dd - mm - yy  |
| Display        | ✓ = Inverse Enabled / ✗ = Inverse disabled.  |
| Tolerances     | Torque 3% default (range 3 – 20), Angle 2° default (range 2 – 20), Turn Angle 0° default (disabled) range 0 – 99.  |
| Output Format  | USER (CSV output for use outside of EvoLog) / EvoLog   |
| 2 Stage Target | ✓ = Enabled / ✗ = disabled (fast Snug followed by Angle Target).   |
| Operation ↶/↷  | ↶, ↷ or ↶+↷ Target Direction. If ↶ or ↷ is set, the Target for the opposite direction is set at the Tool capacity (for undoing fasteners).   |

## View Results (example screens)

Press  to exit the Run screen and show the Menu screen.

Select  and press  to view results.



FIGURE 35 – Select View Results



Press  to View Results.

Erase all will delete all of the results stored on the tool.



FIGURE 36 – Select View Results / Erase All

This example screen shows a Work Group called 'Carrier Hub 1' that was in use for the following saved results. All results are time and date stamped.

Press  or  to scroll through saved readings.

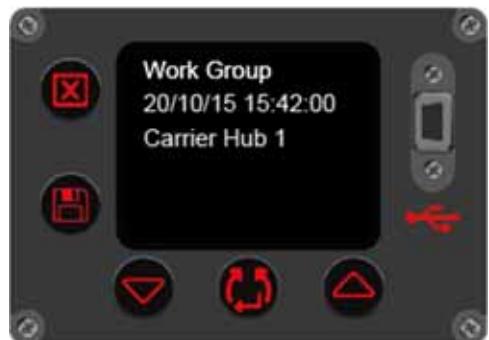


FIGURE 37 – View Work Group

This example screen shows a Work ID called 'Pretensioning' that was in use for the following saved results.

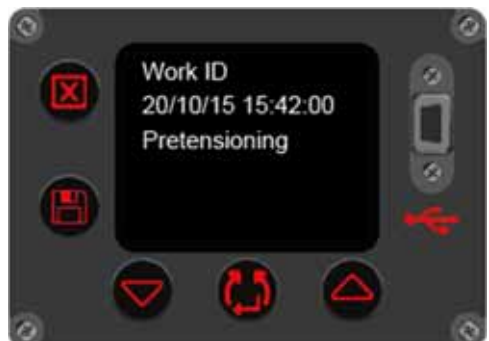


FIGURE 38 – View Work ID

This example screen shows a User ID called 'John Smith' that was in use for the following saved results.




**FIGURE 39 – View User ID**

This example screen shows a 400 N·m Audit result.



**FIGURE 40 – View Result**


Press  to display the memory Record #.



**FIGURE 41 – View Record #**




## Tool Information

Press  to select View Tool Information to begin a cycle through tool information screens. The Tool Capacity, Voltage and Date/Time will be shown first. (see Figure 43 below).




**FIGURE 42** – Select View Tool Information

Press  to continue cycle. The Tool Serial # and Tool Name will then be shown (see Figure 44 below).




**FIGURE 43** – View Tool Capacity, Voltage, Date/Time.

Press  to continue cycle and show installed software versions (see Figure 45 below).



**FIGURE 44** – View Tool Serial # / Name

Press  to continue cycle and show the Bluetooth® Smart screen (see Figure 46 below).



**FIGURE 45** – View Motor / Display Software Version #'s


Press  to continue cycle and show the Error Log (see Figure 47 below).



FIGURE 46 – Bluetooth® Smart


Press  to continue cycle and show the Tool Statistics (see Figure 48 below).



FIGURE 47 – View Error Log

This screen shows the usage statistics for the tool.



Press  to continue cycle and show the Tool Usage (see Figure 49 below).



FIGURE 48 – View Tool Statistics

This screen shows the Tool usage since last reset.

Press  to end the cycle and return to the menu screen (see Figure 42).

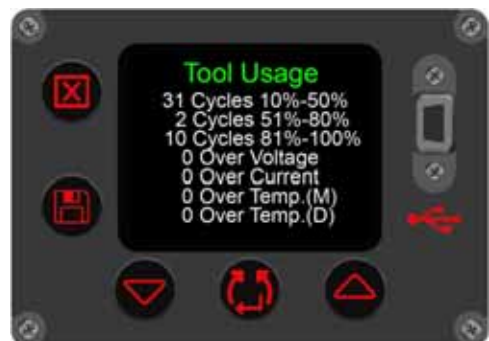


FIGURE 49 – View Tool Usage



# OPERATING INSTRUCTIONS



**WARNING:** KEEP HANDS CLEAR OF THE REACTION BAR.



**WARNING:** WHEN USING THIS TOOL IT MUST BE SUPPORTED AT ALL TIMES IN ORDER TO PREVENT UNEXPECTED RELEASE IN THE EVENT OF FASTENER OR COMPONENT FAILURE.


## Tightening

1. Fit the tool with the correct size impact or high quality socket to suit fastener.

**TIP:** For added safety it is recommended to secure the socket to the drive square. This is often achieved using a pin and O ring, see socket manufacturer for guidance.

2. Ensure the Clockwise/Counter-clockwise display arrow is correct.



Press  to change direction (if required).

3. Ensure Torque, Torque & Angle or Audit Torque target shown is correct.

### Torque

In Torque mode the tool applies torque until the target torque is achieved.

### Torque and Angle

Torque and Angle is achieved in 2 steps, see figure 50:

- 3.1. The tool applies a Torque.  
Ensure fastener has been pre-torqued above this value.
- 3.2. The tool applies the target Angle.
- 3.3. An additional Final Torque verification check can be set.
- 3.4. With '2 Stage Target' enabled, press the trigger to apply the Torque step at fast speed. Press the trigger again to apply target Angle.

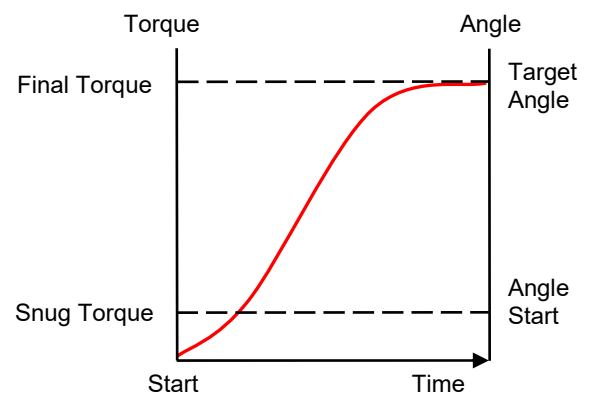


FIGURE 50 – Angle Mode

### Audit Torque

Audit Torque is intended for checking. The tool runs slower and gives a Torque and Angle result.

4. Rotate the handle into a convenient position relative to the reaction bar. Fit the tool onto the fastener to be tightened with the reaction bar adjacent to the reaction point. See figure 51.
5. Adopt a posture to counteract normal or unexpected movement of the tool due to reaction forces.
6. Press and release trigger to slowly bring reaction bar into contact with the reaction point.

**NOTE:** Bringing into contact at speed can lead to increased operator danger, fastener damage, reaction point damage and torque inaccuracies especially on high torque rate joints.



FIGURE 51 – Clockwise Operation

7. Fully press the trigger and keep fully pressed until tool stops, then release trigger.

8. Joint complete. See colour of displayed value for pass / fail status.



FIGURE 52 – Torque Target result (shown as red for fail)



FIGURE 53 – Torque & Angle target (with Final Torque) result (shown as green for pass)



FIGURE 54 – Audit Torque target result (showing achieved torque and output (bolt) movement in degrees)






| LED Status | Meaning                                  | Delay To Next Run | Action                          |
|------------|--|-------------------|---------------------------------|
| ● ✓        | Fastener tightened to specification.     | 2 seconds         | None                            |
| ● ✗        | Fastener NOT tightened to specification. | 2 seconds         | Release fastener and re-tighten |

9. Remove the tool from the fastener.

**TIP:** When tightening multiple fasteners on a flange it is recommended to mark each fastener when tight.

The Turn Angle setting can be used as a means of identifying an already tightened fastener. This is even more important when using the TORQUE & ANGLE mode as applying additional angle to a tightened fastener will increase the risk of operator danger, fastener damage and flange damage.

## Saving Results

| Auto Reset = | Button Operation (after a successful tightening)  |
|--------------|---|
| x            | <p>Press either the  or  buttons to Save the displayed (joint complete) reading and reset the tool, ready for the next tightening operation.</p> <p>Press the  button will reset the tool ready for the next tightening operation <b>without</b> saving the (joint complete) reading.</p>                |
| ✓            | <p>Press the  button to toggle between Save and No Save.</p> <p>When the Save icon  is displayed, the next displayed (joint complete) reading will be saved and automatically reset the tool ready for the next tightening operation after the 'Hold Time' setting has expired.</p> <p>The next displayed (joint complete) reading will <b>not</b> be saved if the icon is not shown.</p> |

**NOTE:** The Save icon will be shown in red when the tool is in 'Logging' mode. See EvoLog operators manual (part number 34427) for more details.

## Releasing

1. Fit the EvoTorque®2 with the correct size impact or high quality socket to suit the fastener to be released.

**TIP:** For added safety it is recommended to secure the socket to the drive square. This is often achieved using a pin and O ring, see socket manufacturer for guidance.

2. Ensure the clockwise/counter-clockwise display arrow is correct.

Press  to set direction.

3. Rotate the handle into a convenient position relative to the reaction bar. Fit the tool onto the fastener to be released with the reaction bar adjacent to the reaction point. See figure 55.
4. Adopt a posture to counteract normal or unexpected movement of the tool due to reaction forces.
5. Press and release trigger to slowly bring reaction bar into contact with the reaction point.
6. Fully press the trigger and keep fully pressed until the threaded fastener releases.



**FIGURE 55 – Anti-Clockwise Operation**

**TIP:** If unable to release the fastener, increase the target torque. The tool will automatically limit itself to the maximum tool output torque.

# MAINTENANCE



**WARNING: ENSURE THE TOOL IS DISCONNECTED FROM MAINS SUPPLY BEFORE MAINTENANCE.**

For optimum performance and safety, regular tool maintenance is required. The user maintenance is limited to that stipulated in this section. Any other maintenance or repairs should be carried out by Norbar or a Norbar distributor. Maintenance intervals will depend on the tool usage and the environment in which it is being used. The maximum recommended maintenance and recalibration interval is 12 months.

**TIP: Steps the user can take to reduce the amount of maintenance required include:**

- 1. Use the tool in a clean environment**
- 2. Maintain the correct torque reaction**
- 3. Carry out daily checks**

## Daily Checks

It is recommended to check the overall condition of the tool every day.

Check power cord for damage – if faulty contact Norbar or Norbar distributor.

Ensure PAT test on tool is within date.

Test the external RCD in the mains supply (if fitted).

Ensure tool is clean - DO NOT use abrasives or solvent based cleaners.

Ensure fan and ventilation slots are clean and dust free. If cleaned with compressed air wear eye protection.

Free run tool to ensure motor and gearbox are smooth and quiet.

## Calibration

Your tool has been supplied with a certificate of calibration.

To maintain the specified accuracy it is recommended that the tool is recalibrated at least once per year.

Recalibration should be carried out at Norbar or by a Norbar distributor, where all the facilities to ensure the instrument is functioning at maximum accuracy are available.

Do not remove tool casing; there are no calibration settings inside.

## Portable Appliance Testing

Portable Appliance Testing (PAT testing) is officially known as “In-service Inspection & Testing of Electrical Equipment”.

This is often a mandatory requirement in local regulations or factory procedures.

The tests are to ensure that the equipment has not suffered damage or faults in the electrical connections that could cause potential danger to the operator.

A competent person should inspect then test the tool for earth continuity (Earth Bond) and Insulation resistance (Electric Strength); other tests may apply.

The frequency of test will depend on many factors including the tool application and environment.

## Gearbox

Under normal operating conditions it is not necessary to re-grease the gearbox. The gearbox contains Lubcon Turmogrease Li 802 EP.

## Drive Square

If the tool output drive is subject to torque overload there is potential for catastrophic tool damage. To reduce this risk the output drive square has been designed, like a fuse, so it will shear first. The output drive square is easy and quick to replace, for part numbers see ACCESSORIES listed in the INTRODUCTION. The drive square is NOT covered by the standard product warranty.



**FIGURE 56 – Drive Square Replacement**

To replace the drive square:

1. Unplug tool from mains supply.
2. Support tool in a horizontal position
3. Use 4mm hex key (supplied) to remove the screw and then remove drive square. If the square has sheared it may be necessary to use pliers to remove the broken parts.
4. Fit new drive square.
5. Fit new screw. Tighten to 9 N·m (M5).

**TIP:** If the drive square fails continually then seek advice from Norbar or a Norbar distributor.

## Product Disposal



This symbol on the product indicates that it must not be disposed of in the general waste.

Please dispose of according to your local recycling laws and regulations. Contact your distributor or see the Norbar website ([www.norbar.com](http://www.norbar.com)) for further recycling information.

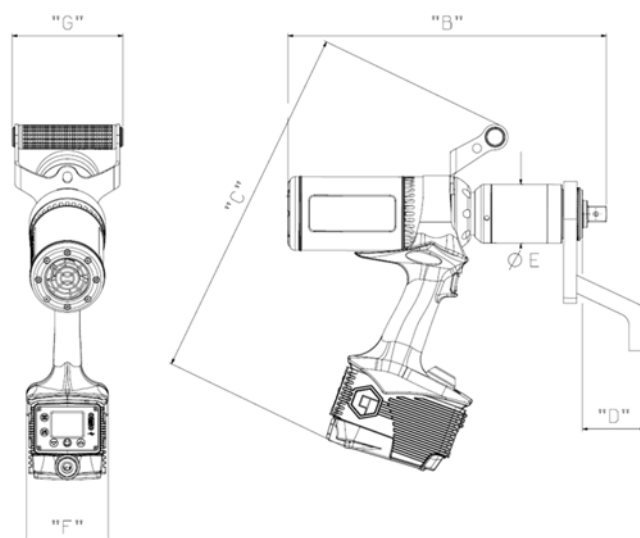
# SPECIFICATIONS - EvoTorque<sup>®2</sup>

| Part Number  | Torque  |          | Tool Speed*<br>(Free Running) | Tool Weight (kg) | Reaction Weight (kg) | Case & Ancillaries (kg) |
|--|---------|----------|-------------------------------|------------------|----------------------|-------------------------|
|  | Minimum | Maximum  |                               |                  |                      |                         |
| 180220.B06 / 180230.B06                            | 100 N·m | 1000 N·m | 21 rpm                        | 10.4             | 1.5                  | 6.0                     |
| 180221.B06 / 180231.B06                            | 135 N·m | 1350 N·m | 17 rpm                        | 10.4             | 1.5                  | 6.0                     |
| 180222.B08 / 180232.B08                            | 200 N·m | 2000 N·m | 11 rpm                        | 10.8             | 1.5                  | 6.0                     |
| 180229.B08 / 180239.B08                            | 270 N·m | 2700 N·m | 10 rpm                        | 10.75            | 1.5                  | 6.0                     |
| 180223.B08 / 180233.B08                            | 270 N·m | 2700 N·m | 8.5 rpm                       | 12.85            | 2.6                  | 6.0                     |
| 180227.B08 / 180237.B08                            | 350 N·m | 3500 N·m | 6 rpm                         | 12.85            | 2.6                  | 6.0                     |
| 180224.B08 / 180234.B08<br>180228.B08 / 180238.B08 | 400 N·m | 4000 N·m | 6 rpm                         | 12.85            | 2.6                  | 6.0                     |
| 180225.B12 / 180235.B12                            | 600 N·m | 6000 N·m | 3.3 rpm                       | 16.8             | 3.9                  | 6.0                     |
| 180226.B12 / 180236.B12                            | 700 N·m | 7000 N·m | 3.3 rpm                       | 16.8             | 3.9                  | 6.0                     |

\* = Tool speed is reduced for Angle mode, Audit mode and for <20% capacity targets.

**NOTE:** Tools are calibrated from 20% to 100% of the maximum operating range.

| Part Number             | Dimensions (mm) |     |    |     |     |       |
|-------------------------|-----------------|-----|----|-----|-----|-------|
|                         | B               | C   | D  | E   | F   | G     |
| 180220.B06 / 180230.B06 | 390             | 438 | 77 | 72  | 100 | 135.5 |
| 180221.B06 / 180231.B06 | 390             | 438 | 77 | 72  | 100 | 135.5 |
| 180222.B08 / 180232.B08 | 425             | 438 | 77 | 72  | 100 | 135.5 |
| 180229.B08 / 180239.B08 | 393             | 438 | 77 | 80  | 100 | 135.5 |
| 180223.B08 / 180233.B08 | 450             | 438 | 75 | 92  | 100 | 135.5 |
| 180227.B08 / 180237.B08 | 450             | 438 | 75 | 92  | 100 | 135.5 |
| 180224.B08 / 180234.B08 | 450             | 438 | 75 | 92  | 100 | 135.5 |
| 180228.B08 / 180238.B08 | 450             | 438 | 75 | 92  | 100 | 135.5 |
| 180225.B12 / 180235.B12 | 480             | 438 | 95 | 119 | 115 | 135.5 |
| 180226.B12 / 180236.B12 | 480             | 438 | 95 | 119 | 115 | 135.5 |



**FIGURE 57 – Tool Dimensions**

|                        |  |
|------------------------|--|
| Torque Accuracy:       | ±3% of target torque on 100° joint for calibrated range (see calibration certificate).   |
| Torque Setting:        | 10% to 100% of tool capacity.  |
| Angle Accuracy:        | ±2°.   |
| Angle Setting:         | 10° to 720°.   |
| Angle Start Threshold: | 10% to 100% of tool capacity.  |
| Display:               | Colour OLED (160 x 128 pixels)   |
| USB                    | 2.0  |
| Bluetooth®:            | Bluetooth® Smart 4.0<br>“Contains Transmitter Module FCC ID: QOQBLE112”<br>“Contains Transmitter Module IC: 5123A-BGTBLE112”<br>Frequency: 2.402 GHz to 2.480 GHz<br>Maximum power transmitted: +3dBm to -23dBm<br>Wireless range tested to 6m. Can work over 20m in an ideal environment  |
| Memorized readings:    | 3000   |
| Vibration:             | The vibration total value does not exceed 2.5m/s <sup>2</sup> .<br>Highest measured tool vibration $a_h = 0.304 \text{ m/s}^2$ .<br>The declared vibration and noise emission values have been measured in accordance with a standard test method and may be used for comparing one tool with another.<br>The declared vibration and noise emission values may also be used in preliminary assessment of exposure. |



**WARNING:** THE VIBRATION AND NOISE EMISSIONS DURING ACTUAL USE OF THE POWER TOOL CAN DIFFER FROM THE DECLARED VALUES DEPENDING ON THE WAYS IN WHICH THE TOOL IS USED ESPECIALLY WHAT KIND OF WORKPIECE IS PROCESSED.



**WARNING:** IDENTIFY SAFETY MEASURES TO PROTECT THE OPERATOR THAT ARE BASED ON AN ESTIMATION IN THE ACTUAL CONDITIONS OF USE (TAKING ACCOUNT OF ALL PARTS OF THE OPERATING CYCLE SUCH AS THE TIMES WHEN THE TOOL IS SWITCHED OFF AND WHEN IT IS RUNNING IDLE IN ADDITION TO THE TRIGGER TIME).

|                       |  |
|-----------------------|--|
| Sound Pressure Level: | $L_{pA}$ does not exceed 70 dB(A).   |
| Ingress Protection:   | IP44 (Protection against 1mm solid objects & splashing water) see EN 60529.                  |
| Environment:          | Industrial. Store in a clean and dry environment.  |
| Temperature Range:    | -20°C to +50°C (operating). -20°C to +60°C (storage).  |
| Operating Humidity:   | 85% Relative Humidity @ 30°C maximum.  |
| Voltage Requirement:  | 110 V a.c. (99-132 V a.c.) or 230 V a.c. (198-264 V a.c.) at 50-60Hz, see Tool Rating Plate. |
| Current Requirement:  | 10A (for 110 V a.c. tools) or 5A (for 230 V a.c. tools).                                     |
| Fuse Fitted:          | 15A (for 110 V a.c. tools) or 12A (for 230 V a.c. tools).                                    |

*Due to continuous improvement all specifications are subject to change without prior notice.*

**NOTE:** If equipment is used in a manner not specified by the manufacturer, the protection provided by the equipment could be impaired.

# SPECIFICATIONS - USB Bluetooth® Smart adapter



## FCC and IC

This equipment has been tested and found to comply with the limits for a Class B digital device, pursuant to Part 15 of the FCC Rules. These limits are designed to provide reasonable protection against harmful interference in a residential installation.

This equipment generates, uses and can radiate radio frequency energy and, if not installed and used in accordance with the instructions, may cause harmful interference to radio communications. However, there is no guarantee that interference will not occur in a particular installation. If this equipment does cause harmful interference to radio or television reception, which can be determined by turning the equipment off and on, the user is encouraged to try to correct the interference by one of the following measures:

- Reorient or relocate the receiving antenna
- Increase the separation between the equipment and receiver
- Connect the equipment into an outlet on a circuit different from that to which the receiver is connected
- Consult the dealer or an experienced radio/TV technician for help

**FCC Caution** : To assure continued compliance, any changes or modifications not expressly approved by the party responsible for compliance could void the user's authority to operate this equipment. (Example - use only shielded interface cables when connecting to computer or peripheral devices).

### **FCC Radiation Exposure Statement**

This equipment complies with FCC RF radiation exposure limits set forth for an uncontrolled environment. This device complies with Part 15 of the FCC Rules. Operation is subject to the following two conditions:

- (1) This device may not cause harmful interference, and
- (2) This device must accept any interference received, including interference that may cause undesired operation.

## Industry Canada

### **IC Statements:**

This device complies with Industry Canada licence-exempt RSS standard(s). Operation is subject to the following two conditions: (1) this device may not cause interference, and (2) this device must accept any interference, including interference that may cause undesired operation of the device.

Under Industry Canada regulations, this radio transmitter may only operate using an antenna of a type and maximum (or lesser) gain approved for the transmitter by Industry Canada. To reduce potential radio interference to other users, the antenna type and its gain should be so chosen that the equivalent isotropically radiated power (e.i.r.p.) is not more than that necessary for successful communication.

### **Déclaration d'IC :**

Ce dispositif est conforme aux normes RSS exemptes de licence d'Industrie Canada. Son fonctionnement est assujéti aux deux conditions suivantes : (1) ce dispositif ne doit pas provoquer de perturbation et (2) ce dispositif doit accepter toute perturbation, y compris les perturbations qui peuvent entraîner un fonctionnement non désiré du dispositif.

Selon les réglementations d'Industrie Canada, cet émetteur radio ne doit fonctionner qu'avec une antenne d'une typologie spécifique et d'un gain maximum (ou inférieur) approuvé pour l'émetteur par Industrie Canada. Pour réduire les éventuelles perturbations radioélectriques nuisibles à d'autres utilisateurs, le type d'antenne et son gain doivent être choisis de manière à ce que la puissance isotrope rayonnée équivalente (P.I.R.E.) n'excède pas les valeurs nécessaires pour obtenir une communication convenable.



## CE

USB Bluetooth® Smart adapter is in conformity with the essential requirements and other relevant requirements of the RED Directive (2014/54/EU).

## South-Korea

USB Bluetooth® Smart adapter is certified in South-Korea with certification number: KCC-CRM-BGT-BLED112

## Japan

USB Bluetooth® Smart adapter has MIC Japan type certification with certification number: 003WWA111471

## Brazil



Este equipamento opera em caráter secundário, isto é, não tem direito à proteção contra interferência prejudicial, mesmo de estações do mesmo tipo e não pode causar interferência a sistemas operando em caráter primário.

# DECLARATION OF CONFORMITY

## UK Declaration of Conformity (No 0008V2)

### The object of the declaration:

EvoTorque® 2. Model Name (Part Number):

ET2-72-1000-110 (180230.B06), ET2-72-1350-110 (180231.B06), ET2-72-2000-110 (180232.B08), ET2-80-2700-110 (180239.B08), ET2-92-2700-110 (180233.B08), ET2-92-3500-110 (180237.B08), ET2-92-4000-110 (180234.B08), ET2-92-4000-110 (180238.B08), ET2-119-6000-110 (180235.B12), ET2-119-7000-110 (180236.B12), ET2-72-1000-230 (180220.B06), ET2-72-1350-230 (180221.B06), ET2-72-2000-230 (180222.B08), ET2-80-2700-230 (180229.B08), ET2-92-2700-230 (180223.B08), ET2-92-3500-230 (180227.B08), ET2-92-4000-230 (180224.B08), ET2-92-4000-230 (180228.B08), ET2-119-6000-230 (180225.B12) & ET2-119-7000-230 (180226.B12).

Serial Numbers – All.

### The object of the declaration described above is in conformity with the relevant UK statutory requirements:

Supply of Machinery (Safety) Regulations 2008

Electromagnetic Compatibility Regulations 2016

Radio Equipment Regulations 2017

The Restriction of the Use of Certain Hazardous Substances in Electrical and Electronic Equipment Regulations 2012

### The object of the declaration described above has been designed to comply with the following standards:

|   |
|---|
| BS EN 62841-1:2015 & BS EN 62841-2-2:2014                                     |
| BS EN IEC 61000-6-2:2019 & BS EN IEC 61000-6-4:2019                           |
| ETSI EN 301 489-1 v.2.1.1, ETSI EN 301 489-17 v3.1.1 & ETSI EN 300 328 v2.1.1 |

### The basis on which conformity is being declared:

This declaration of conformity is issued under the sole responsibility of the manufacturer. The technical documentation required to demonstrate that the products meet the requirements of the above legislation has been compiled by the signatory below and is available for inspection by the relevant enforcement authorities.

The UKCA mark was first applied in: 2021.

Signed for and on behalf of Norbar Torque Tools Ltd.

Signed:



Full Name:

Trevor Mark Lester B.Eng.

Date:

9 September 2021

Authority:

Compliance Engineer

Place:

Norbar Torque Tools Ltd., Wildmere Road, Banbury, Oxfordshire. OX16 3JU

## EU Declaration of Conformity (No 0008V5)

### The object of the declaration:

EvoTorque® 2. Model Name (Part Number):

ET2-72-1000-110 (180230.B06), ET2-72-1350-110 (180231.B06), ET2-72-2000-110 (180232.B08), ET2-80-2700-110 (180239.B08), ET2-92-2700-110 (180233.B08), ET2-92-3500-110 (180237.B08), ET2-92-4000-110 (180234.B08), ET2-92-4000-110 (180238.B08), ET2-119-6000-110 (180235.B12), ET2-119-7000-110 (180236.B12), ET2-72-1000-230 (180220.B06), ET2-72-1350-230 (180221.B06), ET2-72-2000-230 (180222.B08), ET2-80-2700-230 (180229.B08), ET2-92-2700-230 (180223.B08), ET2-92-3500-230 (180227.B08), ET2-92-4000-230 (180224.B08), ET2-92-4000-230 (180228.B08), ET2-119-6000-230 (180225.B12) & ET2-119-7000-230 (180226.B12).

Serial Numbers – All.

### The object of the declaration described above is in conformity with the relevant union harmonisation legislation:

Directive 2006/42/EC on Machinery Directive.

Directive 2014/30/EU on Electromagnetic Compatibility.

Directive 2014/53/EU on Radio Equipment.

Directive 2011/65/EU of the European Parliament and of the Council of 8 June 2011 on the restriction of the use of certain hazardous substances in electrical and electronic equipment (RoHS).

### The object of the declaration described above has been designed to comply with the following standards:

|  |
|--|
| EN 62841-1:2015 & EN 62841-2-2:2014                            |
| EN IEC 61000-6-2:2019 & EN IEC 61000-6-4:2019                  |
| EN 301 489-1 v.2.1.1, EN 301 489-17 v3.1.1 & EN 300 328 v2.1.1 |

### The basis on which conformity is being declared:

This declaration of conformity is issued under the sole responsibility of the manufacturer.

The technical documentation required to demonstrate that the products meet the requirements of the above Directives has been compiled by the signatory below and is available for inspection by the relevant enforcement authorities.

The CE mark was first applied in: 2016.

### The authorised representative within the European Union (EU) is:

Francesco Frezza Snap-on Equipment S.r.l. Via Prov. Carpi, 33 42015 Correggio RE Italy

Signed for and on behalf of Norbar Torque Tools Ltd.

Signed:



Full Name:

Trevor Mark Lester B.Eng.

Date:

9 September 2021

Authority:

Compliance Engineer

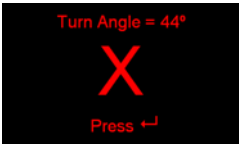
Place:

Norbar Torque Tools Ltd., Wildmere Road, Banbury, Oxfordshire. OX16 3JU

# TROUBLE SHOOTING

The following is only a guide, for more complex fault diagnoses please contact Norbar or a Norbar distributor.

| Problem  | Likely Reason   | Likely Solutions  |
|--|---|---|
| No Display   | No mains power  | Check electrical mains power is working   |
|  | External fuse or circuit breaker has operated                       | Check fuse or circuit breaker   |
|  | External RCD has operated   | Check for faults then reset the RCD   |
| Tool output does not rotate when trigger is pressed  | Tool is on tight fastener   | Remove from fastener<br>Check correct setting of tool direction   |
|  | Tool is off   | Ensure tool is ON (display lit)   |
|  | Tool is in set up mode  | Exit set up to return to operate mode   |
|  | Output drive square sheared   | See MAINTENANCE section to replace drive square   |
|  | Gear train or motor is damaged                                      | Contact Norbar  |
| Torque adjustment has no effect  | Trigger is pressed  | Release trigger   |
|  | In menu mode  | Select exit   |
| Red LED shown  | Bolt has not made correct torque or angle                           | Trigger released early<br><br>Fastener sheared or thread stripped |
|  | Tool error  | Contact Norbar  |
|  | Tool slammed into fastener.   | Bring reaction bar slowly into position.  |
| E21 or E16 (error codes)   | 230 V tool used on 110 V supply                                     | Use correct mains voltage.  |
| Measured angle is less than EvoTorque®2 applied  | Flex in reaction bar or reaction point.                             | Ensure reaction bar & reaction point are rigid.   |
|  | Overuse at high torque.   | Rest tool. The tool is not operational until this message clears.   |
| <br>"M=xx°C" Motor too hot.   | Cooling fan blocked / broken.                                       | Turn tool off. Unblock / contact Norbar or a norbar distributor to fix fan.   |
| <br>"D=xx°C" Display too hot. | Overuse at high torque.   | Rest tool. The tool is not operational until this message clears.   |
| Click sound from motor when not running.   | Temperature measurement.  | Normal operation.   |
| E>1000 N·m, E>1350 N·m<br>E>2000 N·m, E>2700 N·m<br>E>4000 N·m, E>6000 N·m<br>E>7000 N·m                         | Demand for torque greater than tool capacity.                       | Use larger capacity tool.   |
| Logo flashes   | Cooling fan is blocked / broken                                     | Turn tool off. Unblock / contact Norbar or a norbar distributor to fix fan.   |
| Tool runs slower for Torque only Targets < 20% capacity and Audit mode.  | Normal operation.   | Normal operation.   |
|                               | Slam joint.<br>a) The reaction bar is moving too fast (tightening). | Undo and re-tighten the joint.  |
|  | b) Un-doing a tightened joint with too lower Target.                | Use a larger Target value than the tightening Target.   |

| Problem   | Likely Reason   | Likely Solutions                   |
|---|---|------------------------------------|
| Not working with EvoLog   | Output Format has been set to USER                    | Change the Output Format to EvoLog |
| Lost PIN number   |   | Contact Norbar                     |
| Battery symbol shown in power up  |   | Contact Norbar                     |
|  | a) Turn Angle set too High.<br>b) Joint already tight | Decrease Turn Angle setting.       |

## GLOSSARY OF TERMS

| Word or Term   | Meaning  |
|----------------|--|
| A              | Amps   |
| Audit          | Checking a pre-tightened joint.  |
| Auto reset     |  |
| a.c.           | Alternating Current  |
| A/F            | Across Flats   |
| Bi-directional | Clockwise and Counter Clockwise  |
| CSV            | Comma Separated Values   |
| ET2            | EvoTorque®2  |
| EvoLog         | Software supplied with EvoTorque® 2 for data comparison and tool setting   |
| EvoTorque®2    | Product Name   |
| Fastener       | Bolt or stud to be tightened   |
| Nose Extension | A reaction type used where tool access is restricted, a typical example is on wheel nuts on heavy vehicles   |
| Reaction Bar   | Item to counteract applied torque. Also called Reaction Plate.   |
| Record         | A memory location. A Work Group, Work ID, User ID or Result saved in the tools memory.   |
| RCD            | Residual Current Device, for disconnecting the electrical supply in the case of a fault; so protecting the operator.<br>A device with a trip value of 30mA or less is recommended.   |
| Target         | The Torque, Torque & Angle or Audit Torque that the tool is set to achieve (when active).  |
| Snug and Angle | Applies a torque first and then an angle after.  |
| Torque Rate    | The increase in torque with angular displacement while advancing a fastener in a threaded joint (as defined in ISO 5393 Rotary Tools for Threaded Fasteners – Performance Test Method.)<br>A LOW torque rate is often referred to as a SOFT joint.<br>A HIGH torque rate is often referred to as a HARD joint. |
| Turn Angle     | Minimum angle of rotation of a Torque only fastener  |
| User ID        | Identification of the person using the tool.   |
| V              | Volts  |
| Work ID        | Identification of a group of Results.  |
| Work Group     | Specific group of a number of Work IDs and Targets.  |

# NOTES

## **NORBAR TORQUE TOOLS LTD**

Wildmere Road, Banbury,  
Oxfordshire, OX16 3JU

UNITED KINGDOM

Tel + 44 (0)1295 270333

Email [enquiry@norbar.com](mailto:enquiry@norbar.com)

For the most up-to-date  
version of the Operator's  
Manual, please scan the QR  
code below.



To find your local Norbar  
company or distributor,  
please scan the QR code  
below.



[www.norbar.com](http://www.norbar.com)